

# Current Transformer Model 308MR

Window Diameter 5.75"

REGULATORY AGENCY APPROVALS



Manufactured to meet the requirements of ANSI/IEEE C57.13.  
Classified by U.L. in accordance with IEC 44-1

## Multi-Ratio



**APPLICATION:**  
Relaying.

**FREQUENCY:**  
50-400 Hz.

**INSULATION LEVEL:**  
600 Volts, 10 kV BIL full wave.

Terminals are brass screws No. 10-32 with one flatwasher and lockwasher.

The transformer winding is arranged so that the turns are fully distributed between all tops.

Order mounting bracket kit 0221B01527 separately.

Approximate weight 34 lbs.

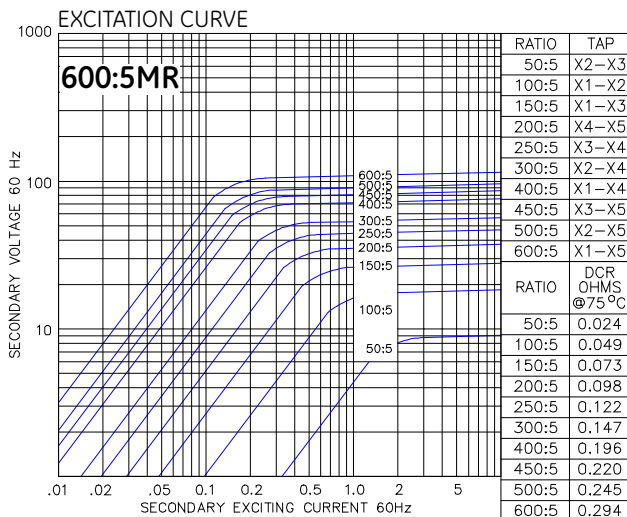

Model 308-601MR

CATALOG NUMBER	RELAY CLASS	CONTINUOUS THERMAL RATING FACTOR	
		@ 30°C	@ 55°C
308-601MR	C100	2.0	2.0
308-122MR	C200	2.0	1.5
308-202MR	C400	1.5	1.0
308-302MR	C400	1.33	1.0
308-402MR	C400	1.0	0.8

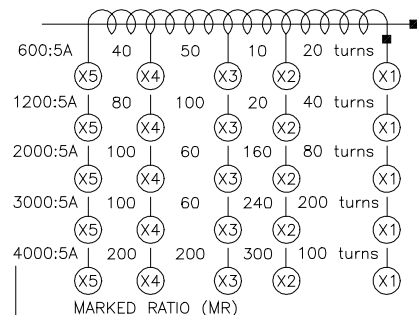

# Model 308MR

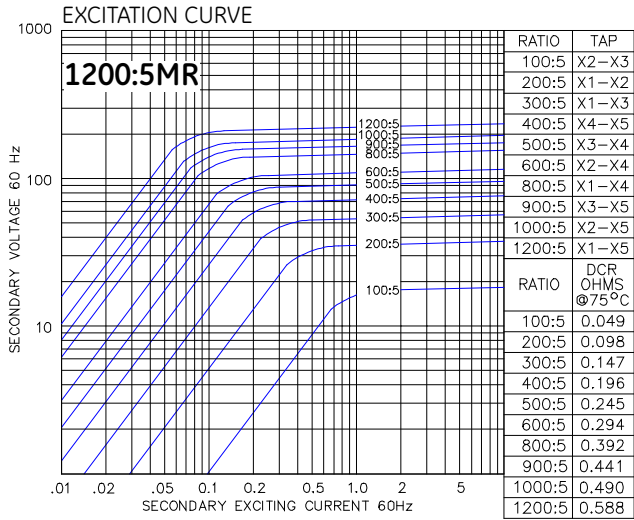

**Model 308-122MR**

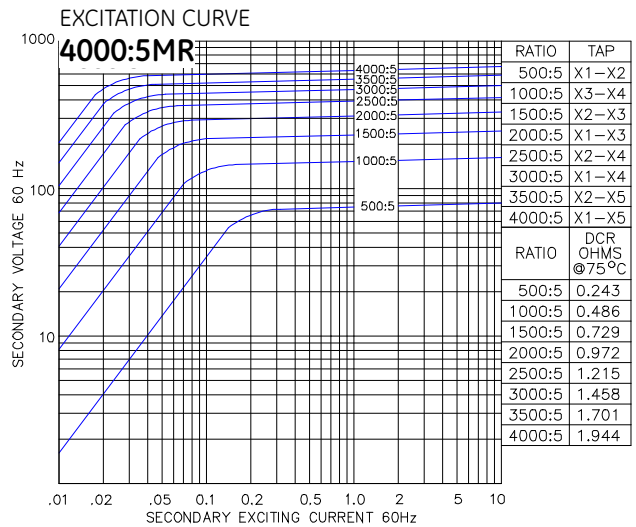

**Model 308-402MR**

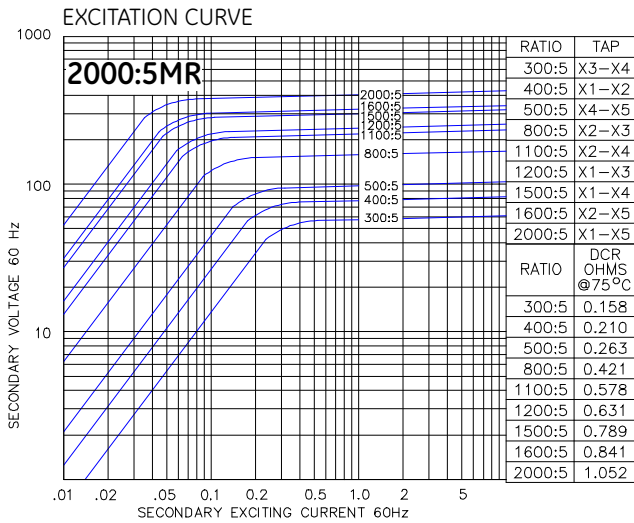

**Model 308-202MR**

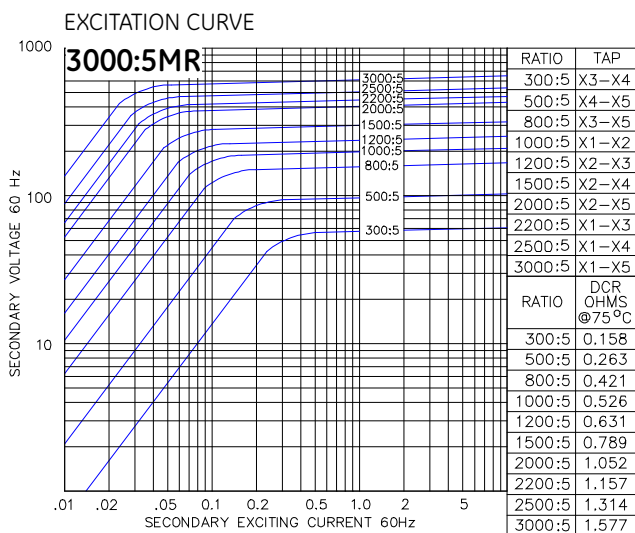
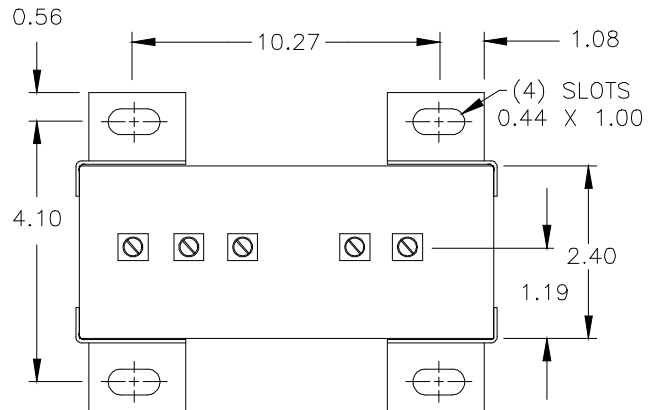

**Model 308-302MR**

